

CONTENTS

1. Introduction	1
2. Precautions.....	1
3. Before Using the Product	1
3-1 Unpacking and Checking.....	1
3-2 Installing Components.....	1
3-3 Leveling the Scale	1
4. Product Introduction	2
4-1 Display.....	2
4-2 Keypad	3
5. Analog Section	4
6. Setting mode.....	4
7. Dual Channel	5
7-1 Diagram of sub channel connector	5
7-2 Installation Process.....	5
7-3 Setup	6
7-4 Maximum Capacity & Division Setting	6
7-5 Calibration.....	7
7-6 Set AD gain of remote platform.....	8
7-7 Switch between Main scale and Remote platform.....	8
8. Operation	8
8-1 Zero-point.....	8
8-2Tare & Preset Tare	8
8-2-1Tare	8
8-2-2Preset Tare.....	9
8-2-3 Auto-tare	9
8-3 Counting method.....	10
8-3-1Key in a known unit value	10
8-3-2 Sample counting	10
8-3-3 ACAI.....	11
8-4 Accumulation.....	11
8-4-1Choose Accumulation Mode	11
8-4-2Set the Max Account of accumulation	11
8-4-3Manual Accumulation	12
8-4-4Accumulation display	12
8-4-5Print while display of accumulation	13
8-4-6Delete accumulation.....	13

8-5 Print	13
8-5-1 Set A Print form	13
8-5-2 Set Print mode	14
8-6 Serial number	14
8-6-1Set Serial Number Mode.....	14
8-6-2Set Max Serial Number	14
8-6-3Change the Current Serial Number.....	15
8-7 Quantity checking	15
8-7-1Set the high limit of quantity	15
8-7-2Set the low limit of quantity	15
8-7-3Enable / Disable the quantity limit function.....	15
8-8 Weight checking	16
8-8-1Set the high limit of weight checking	16
8-8-2Set the low limit of weight.....	16
8-8-3Enable / Disable the weight limit function.....	16
8-9 Unit weight ID	17
8-9-1Saving ID method 1.....	17
8-9-2Saving ID method 2.....	17
8-9-3Call up ID	17
8-10 Label	18
8-11Time Setting	18
8-12 Error message	19
8-13 Problem & Solution	19
9. Option	20
10. Relay Module Diagram	25

1. Introduction

Thank you for deciding to purchase a JCAII counting scale. This goods has the excellent performance and splendid properties under severe quality management .It is recommended to read this manual in full before using it for good function application.

2. Precautions

- ◎ Place the scale on a flat and stable surface. See 3-3 Leveling the Scale for details.
- ◎ Verify that the input voltage and the plug type matches the local AC power supply.
- ◎ Warm up the scale for 15 minutes before using it the first time.
- ◎ Keep the scale away from EM noise, strong wind and vibration, which might cause incorrect reading.
- ◎ Avoid sudden temperature changes (suitable operating temperature is between $-5^{\circ}\text{C} \sim 40^{\circ}\text{C}$.)
- ◎ Disconnect the power supply when cleaning the scale.
- ◎ Do not immerse the scale in water or other liquids.
- ◎ Service should be performed by authorized personnel only.

3. Before Using the Product

3-1 Unpacking and Checking

Open the package and check the instrument for transport damage. Immediately inform your dealer if you have complaints or if parts are missing. The package should contain:

- Scale body
- User manual
- Stainless steel pan
- Wire (power cord)

3-2 Installing Components

Cover the stainless steel pan on the top housing properly before using the scale.

Important:

Please find the delivery protection screw in the bottom of the scale. Loose it according to the instruction sticker next to it

Before use the scale Loose the screw counter-clockwise to the end

Before move the scale Tighten the screw clockwise to the end

3-3 Leveling the Scale

To compensate for small irregularities or inclinations at the location, the scale can be leveled. The scale is equipped with a level indicator at the front panel .Adjust the adjusting feet until the air bubble in the indicator is centered as shown.







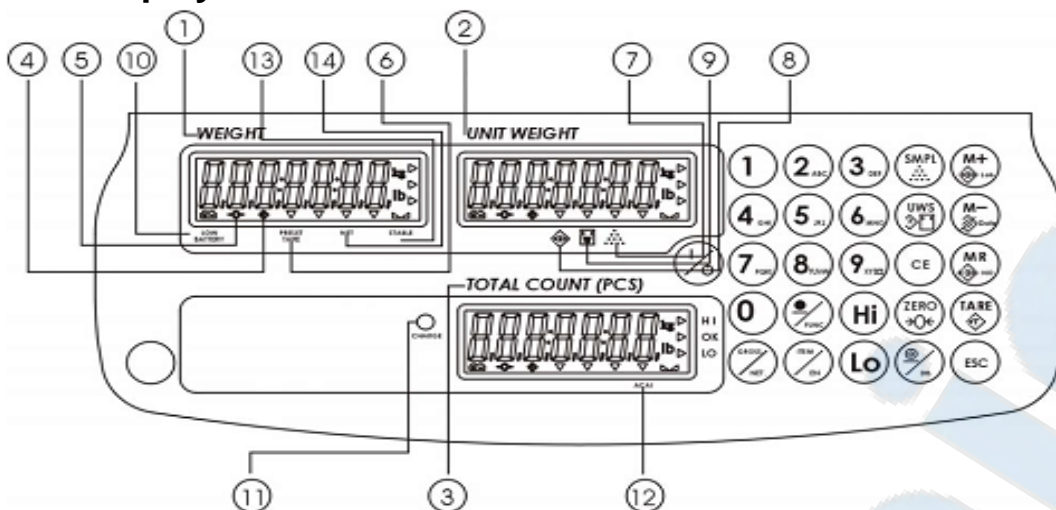

Note: The scale should be leveled each time its location is changed.

4. Product Introduction

4-1 Display



- 1) **Weight Window:** displays weight of object on weighing pan, or accumulated weight value.
- 2) **Unit Weight Window:** displays the average piece weight value, or number of weighments .
- 3) **Total Count Window:** displays the calculated number of pieces on the weighing pan, or accumulated piece count value.
- 4)  Tare or Preset Tare indication.
- 5)  Center of Zero Indication, The zeroing range is $\pm 2\%$ of weighing capacity.
- 6)  Symbol “▼” points at “**PRESET TARE**” when Tare value entered via numeric keys.
- 7)  Under the sample counting mode, Symbol “▼” points at “**SMPL**” when calculated unit weight is lower than 4/5 of scale division or the quantity of sample is less than 10 pieces.
- 8)  “Accumulation” function is enabled under weighing mode.
- 9)  Under entering a known unit weight mode, Symbol “▼” points at “**UW**” when entered unit weight is lower than 4/5 of scale division. Unit weight is too small for ensuring accurate quantity calculations.
- 10) **Low Battery Indicator:** When “” appears, the battery power requires recharging.
- 11) **CHANGE** Charge Lamp

Red--- battery is charging

Green---battery is fully charged

ACAI Symbol “▼” points at “**ACAI**” when Automatic counting accuracy improvement is functioning.

STABLE Stable indication, Symbol “▲▲” appears at the top of “**STABLE**” when scale is in stable condition.

NET Gross weight minus Tare. Symbol “▼” points at “**NET**” when manual Tare or preset are actions are done.

4-2 Keypad

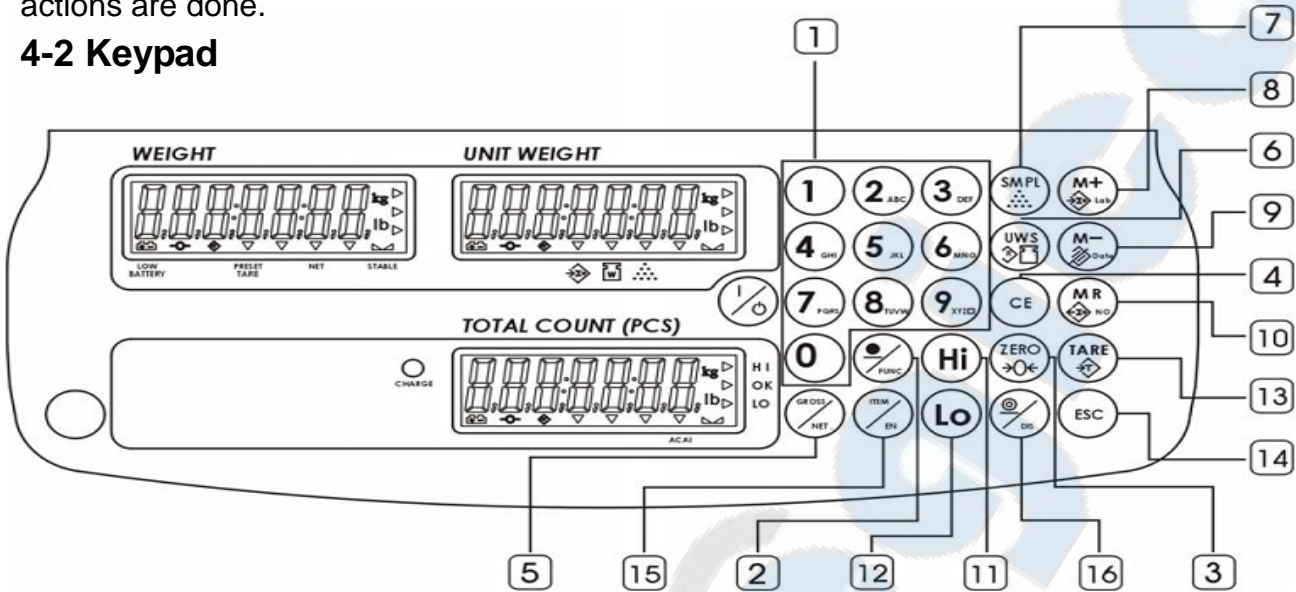

- Enters specific values for tare, unit weight and other data entries.

- Key can be also as a space key when edit label.



- Decimal point
- Initiates function setting



- Sets the weight to zero.



- Clears the indicated input values.



- Displays gross and net weight by turns



- Inputs unit weight



- Enters the sampling mode
- Switches between main scale and remote platform



- Adds the indicated weight or piece count value into Accumulation memory.

- Enters label editing mode

- Steps to next parameter



- Deletes accumulation records
- Display year, date, time
- Go back to previous parameter



- Recalls and displays the accumulated data



- Selects/ sets the Hi Value of weight or piece
- change the next content of parameter



- Selects the Lo value of weight or piece
- Changes to previous content of parameter
- Tare



Give up any setting and return to normal weighing



- Call up unit weight ID
- Enable / switch on relay output function under HI/LO setting.



- Print
- Disable/ switch off relay output function under HI/LO setting.



5. Analog Section



Input sensitivity	1~4mV/V
Zero adj. Range	20% FS
A/D conversion rate	10 times per second.
Load cell excitation	5V DC
Number of load cells.	up to 4x350 ohm loadcells
Resolution.	1/30,000

6. Setting mode

1. Under the weighing mode, long press key  for 3 seconds to enter basic parameter setting mode.



2. Press  or  to switch between parameters from P-00 to P-07

3. Press key  or  to step through all the available setting options.

4. Press key  to save the setting and return to weighing mode.

Parameter description

1. P-00 Power (default: off) Set the period of inactivity before the scale automatically turns off. Options are Off =non power-off, 10, 20,30,40,50, 60, 70, 80 and 90 (minutes).

2. P-01 Backlight (default: auto)

\overline{OFF} =always off ON =always on $Auto$ =turn on when the weight is over 20e

3. P-02 Serial number display (default: off)

\overline{OFF} =never display ON =will display when price is zero

4. P-03 Beep sound (default: in)

in = when check is OK out = when check is Hi/Lo (in , out = using scale's buzzer)
 $E-in$ = when check is OK $E-out$ = when check is Hi/Lo ($E-in$, $E-out$ = using light tower's buzzer)

5. P-04 ACAI (default: off)

Options: off/5/10/15/20/25/30/35/40/45

6. P-05 Printer model (default: normal)

Options: normal / EZ-2P / BP-443D (normal as SH-24 or compatible printer)

7. P-06 Rs-232 Baud Rate (default: 9600)

Options: 19200 / 9600 / 4800 / 2400

8. P-07 Data (default: n81)

Options: n81 / o81 / e81 / n71 / o71 / e71

7. Dual Channel

7-1 Diagram of sub channel connector

- | | |
|---|-----|
| 1 | E+ |
| 2 | E- |
| 3 | S+ |
| 4 | S- |
| 5 | GND |

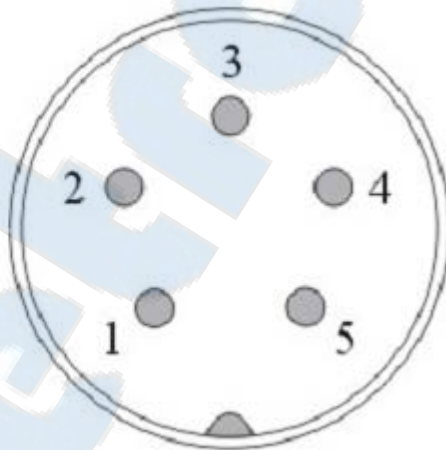

7-2 Installation Process

1. Turn on the main scale
2. Connect the remote platform to JCAII main scale



7-3 Setup

1) Under the weighing mode, long press key  for 3 seconds to enter basic parameter setting mode.





2) Long press key  to enter advance parameter setting mode.



3) Press key  or  to select parameter A-08.



4) Press key  or  to step through all the available setting items.





both = Using main scale together with the remote platform

Sub = Use the remote platform only



main = Use the main scale only

5) Press key  to save the setting and return to weighing mode.

7-4 Maximum Capacity & Division Setting

1) Press and hold  while turning on the scale. Do not release  till *r-0.0000* is displayed in the Total Count window.



2) Use numeric keys together with  to input the new capacity, press key  to clear the indicated input values.



3) Press key  advance to division setting. Use numeric keys to input the new division.



4) Press key  to advance to Maximum Capacity & Division Setting of the remote platform.



5) Repeat step 2-3 to complete the settings.

6) Press key  to save the settings and return to weighing mode.

7-5 Calibration



 = remote platform

 = main scale

Note:

- Please calibrate the main scale first.
- Press key  to switch the calibration for the main scale or remote platform before the zero point calibration.
- You can only do the calibration for the remote platform after you have set the max. capacity and division of the remote platform.

Here take JCAII-6K as an example.

1. Press key  and hold while turning on the scale. Do not release  till **CAL-0** is displayed in the Unit Weight window.

WEIGHT	UNIT WEIGHT	TOTAL COUNT (PCS)
0.0000	CAL-0	 in

2. Press key  to start the zero point calibration and wait till **CAL-1** is displayed in the Unit Weight window. Input the first calibration weight value by the numeric key (6K model, 1/3 of full load is 2kg). And then put the corresponding weights on.

WEIGHT	UNIT WEIGHT	TOTAL COUNT (PCS)
2.000	CAL-1	 in

3... Press key  and wait till **CAL-2** is displayed in the Unit Weight window. And then put the corresponding weights on.

WEIGHT	UNIT WEIGHT	TOTAL COUNT (PCS)
4.000	CAL-2	 in

4. Press key  and wait till **CAL-3** is displayed in the Unit Weight window. And then put the corresponding weights on.

WEIGHT	UNIT WEIGHT	TOTAL COUNT (PCS)
6.000	CAL-3	 in

5. Press key  and wait till **PASS** is displayed in the Total Count window.



WEIGHT	UNIT WEIGHT	TOTAL COUNT (PCS)
6.000	CAL-3	PASS

6. Press key  to save the settings and return to weighing mode



7-6 Set AD gain of remote platform

1. Under normal weighing mode, press  for 3 seconds to enter the basic parameter setting.

2. Press  for 3 seconds to enter the advanced parameter setting.

3. Press key  or  to select parameter A-07

WEIGHT	UNIT WEIGHT	TOTAL COUNT (PCS)
A-07	Ad	32

4. Press  or  to select the AD gain. (Options: 1/2/4/8/16/32/64)

5. Press  to save and return to normal weighing mode.

7-7 Switch between Main scale and Remote platform

Press  to switch between main scale mode and sub channel mode (remote platform)

Note: When accumulation is already in one channel, it can't be accumulated in another channel. When Hi/Lo checking is enable in one channel, Hi/Lo setting can't be accessed and enable in another channel.

8. Operation

8-1 Zero-point

Press  if you do not see "

8-2 Tare & Preset Tare

8-2-1 Tare

1. Under the weighing mode, place a container weighing (eg. 0.100kg) on the pan.

WEIGHT	UNIT WEIGHT	TOTAL COUNT (PCS)
0.100 ^{kg}	0 ^g	0

2. Press key  to complete tare action. The  symbol appears with symbol  pointing







at "NET".

3. Put the load on the container. The display shown is the Net weight. Press key  to see the Gross weight.

4. To clear tare, with an empty pan, press key .

8-2-2Preset Tare

1. Input the tare value using the numeric key together with key .



2. Press key . The  symbol appears with a symbol  pointing at "NET" and another  pointing at "PRESET TARE"

3. Put the load on the container. The display shown is the Net weight. Press key  to see the Gross weight.

5. To clear tare, with an empty pan, press key .

8-2-3 Auto-tare

Set the high limit of the tare value



1. Press  under normal weighing mode.  appears in the Total Count window.



2. Use numeric key to input the high limit value. Eg. 0.100kg.

3. Press  to save and return.

Set the low limit of the tare value

1. Press  under normal weighing mode.  appears in the Total Count window.





2. Use numeric key to input the low limit value. Eg. 0.1kg.

3. Press **Lo** to save and return.

Enable/disable the Auto-tare function

1. Under normal weighing mode, press **Hi** or **Lo**. TARE appears in the Total Count window.

(If not press **TARE**)

2. If you want to enable auto-tare function, press **ITEM/EN**

If you want to disable auto-tare function, press **DIS**

8-3 Counting method

8-3-1 Key in a known unit value

1. Use numeric key to input the unit weight value (eg. 1.2g), then press key **UWS**



2. Put the article on the pan, and the scale starts counting

Note: Symbol “▼” points at “UW” when entered unit weight is lower than 4/5 of scale division. Unit weight is too small for ensuring accurate quantity calculations.

8-3-2 Sample counting

Note: Do tare or zero-point before doing the following steps

1. Put samples onto the weighing pan and input the quantity with the numeric key.



2. Press key **SMPL**. The unit weight is calculated



3. Remove the samples and put on the articles, the scale begins to count

Note: Symbol ▼ appears pointing at “**SMPL**” in the Unit Weight window when sample quantity is less than 10 pieces.

8-3-3 ACAI

Automatic Counting Accuracy Improvement (ACAI) results in a more accurate count by increasing the reference weight without the need to count additional parts. A higher reference weight is important when there is a risk of inconsistent piece weights or if the reference weight is close to the minimum. ACAI uses an initial averaging unit weight to count additional weight that is placed on the scale. After a few seconds, the scale gives a beep as a new higher reference weight is used to recalculate the averaging unit weight. The process can be repeated as long as the additional weight is less than the less than previous reference weight. Once the limit is exceeded ACAI is turned off.

Note:



- If you set the average parameter (P4) to OFF, it means that the scale will do the ACAI in all situations.
- If you set the average parameter to 15, the scale will not work if there is an object shortage or more than $\pm 15\%$ of the unit weight.
- Whether it works or not, depends on the object's tolerant of weight.

8-4 Accumulation



Note: Do tare or zero-point before accumulation

8-4-1 Choose Accumulation Mode

1. Press  with no load on the pan.

2. Press  or  to choose the accumulation mode

 = Manual

 = Auto-accumulate when  symbol appears

 = Auto-accumulate when quantity is between HI – LO limits

 = Auto-accumulate when weight is between HI – LO limits

3. Press  to save and return.

8-4-2 Set the Max Account of accumulation

The max accumulation number is 50. You can change the max accumulation number as following:

For example, if you want to change the accumulation number to 9

1. Press  and the Unit Weight display is blinking.



WEIGHT	UNIT WEIGHT	TOTAL COUNT (PCS)
0000g	9	0

2. Press  to save and return. And now you can accumulate up to 9 times only.

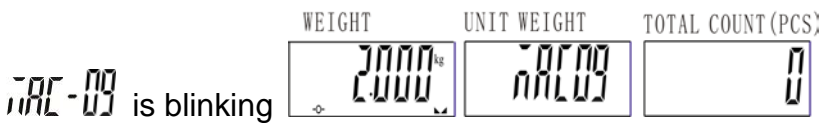
Note: You can change the max accumulation back to 50 times by repeating the above steps. It will beep for 3 seconds when accumulate to the max account (eg. Max accumulation=9) and the



Under this condition, you have the following options:

- Press , it will print every set and total, **ACC-09** is still blinking. (It is only for normal printer SH-24. Label printer could not do it.)
- Press  to return to normal weighing mode, and still keep accumulation.(But if you try to accumulate another set, it will appear **ACC-09** to warn)
- Press  twice to delete all accumulation,

8-4-3 Manual Accumulation

1. Put the article on the pan. Press key . The symbol “**ACC 1**” is blinking in the Unit Weighting



window. This is the first accumulation.

2. The symbol  will appear pointing at the “” after the blinking.





3. Repeat step 1.

4. Press  to return to normal weighing mode.

8-4-4 Accumulation display

1. Press  to see the last accumulation value.

2. Press  once more to see the total accumulations value.

3. After the above two steps, press  again, it will display every accumulation value one by one.

4. Skip 2-3 steps, press any numeric key to see a certain accumulation. For example, if you want to

see the 12th accumulation, press key  .

5. Press  to return to normal weighing mode.

8-4-5 Print while display of accumulation

Note: Only for SH-24

Print a certain accumulation

Enter a certain accumulation display, press  to print.

Print total accumulation

Enter total accumulation display, press  to print.

8-4-6 Delete accumulation



Delete a certain accumulation

1. Enter a certain accumulation display, press  to delete.

2. Press  to return to normal weighing mode.

Delete total accumulation

1. Enter the total accumulation display, press  to delete.

2. Press  again to delete and return to normal weighing mode. If you don't want to delete, press  to return to normal weighing mode.

8-5 Print

Put the load on the pan and press key  to print.

8-5-1 Set A Print form

EZ-2P/BP-443D set 0~99 forms; SH-24 set 0~15 forms

1. Press key  with no load on the pan.

WEIGHT	UNIT WEIGHT	TOTAL COUNT (PCS)
0.0000 ^{kg}	0 ^g	Prt-00
2. Key in the Form Number with numeric key. For example, if you want to choose the 9th form,

press  .

WEIGHT	UNIT WEIGHT	TOTAL COUNT (PCS)
0.0000 ^{kg}	0 ^g	Prt-09

3. Press key  to complete and return to weighing mode.

8-5-2 Set Print mode

1. Press key  with no load on the pan.

2. Press key . The display shown is

WEIGHT	UNIT WEIGHT	TOTAL COUNT (PCS)
0.0000g	1.0000g	Prt---

3. Press key  or  to choose the print mode

 = Manual

 = Print after  appears

 = Print when quantity is ok (with check function)

 = Print when weight is ok (with check function)

 = Print continuously

 = No action

4. Press key  to complete and return to weighing mode.



8-6 Serial number

8-6-1 Set Serial Number Mode

1. Under normal weighing mode, press . It will shown as

WEIGHT	UNIT WEIGHT	TOTAL COUNT (PCS)
0.0000g	5.0001g	52861

(If not, press )

2. Press  or  to choose the serial number mode

 = No action

 = The serial no. plus 1 when  symbol appear.

 = The serial no. plus 1 when quantity is between HI-LO limits

 = The serial no. plus 1 when weight is between HI-LO limits.

3. Press  to save and return.

8-6-2 Set Max Serial Number

The max serial number is 9999, but you can change the max serial number as shown below.

For example: if you want to change the max serial number to 9, do as the following.

1. Press  and the Unit Weight display is blinking.

WEIGHT	UNIT WEIGHT	TOTAL COUNT (PCS)
0.0000g	9	0



2. Press  to save and return.

Note: When the serial number reaches the max, the Unit Weight display will flash **HI** and beep for 3 seconds and then return to normal weighing mode.

And because it has reached the max serial number, it will reset to 1 when the serial number do increase 1.

8-6-3 Change the Current Serial Number

For example: if you want to change the serial number to 9, do as the following.



1. Press  and the Unit Weight display is blinking. 

2. Press  to save and return.

Note: the serial number is starting from 9.

8-7 Quantity checking

8-7-1 Set the high limit of quantity



1. Press  under normal weighing mode. The last high limit value of quantity is blinking in the Total Count window while the arrow is pointing at **HI**. (If not, press )

Eg. 111pieces. 

2. Use numeric key to input the high limit of quantity you want.

3. Press  to save and return.

8-7-2 Set the low limit of quantity



1. Press  under normal weighing mode. The last low limit value of quantity is blinking in the Total Count window while the arrow is pointing at **LO**. (If not, press )

Eg. 111pieces. 

2. Use numeric key to input the low limit of quantity you want.

3. Press  to save and return.

8-7-3 Enable / Disable the quantity limit function

1. Under normal weighing mode, press  or . The display in the Total Count window is blinking. (If not press )

2.If you want to enable the function, press 



If you want to disable the function, press 

Note: When the **HI & LO** checking function is enabled, there will be an arrow pointing between

PERSET TARE and **NET.** 

8-8 Weight checking

8-8-1 Set the high limit of weight checking



1.Press  under normal weighing mode. The display of the weight is blinking in the Weight window while the arrow is pointing at **HI** in the Total Count window. (If not, press )

Eg. 111pieces. 

2. Use numeric key to input the high limit of weight you want.

3. Press  to save and return.

8-8-2 Set the low limit of weight



1. Press  under normal weighing mode. The display of the weight is blinking in the Weight window while the arrow is pointing at **LO** in the Total Count window. (If not, press )

E.g. 111pieces. 

2. Use numeric key to input the low limit of weight you want.

3. Press  to save and return.

8-8-3 Enable / Disable the weight limit function

1. Under normal weighing mode, press  or . The display in the Total Count window is blinking. (If not press )

2. If you want to enable the function, press 

If you want to disable the function, press 

Note: When the **HI & LO** checking function is enabled, there will be an arrow pointing between



8-9 Unit weight ID

Note: possible save up to 50 ID

8-9-1 Saving ID method 1

For example, save 1.23g to ID 12

1. Press under normal weighing mode and the Unit Weight is blinking.

2. Press and key in the accumulation number and the Total Count window will



3. Press to save

8-9-2 Saving ID method 2

.For example, there is a unit weight 1.23g already existing and save it to ID 12



1. Press and key in the accumulation number and the Total Count window will



3. Press to save.

8-9-3 Call up ID

Note: If the Unit Weight display is not showing 0, please press first

1. under normal weighing mode, press

2. Use numeric key to input a certain ID. (eg. to call up ID 13)



3. Press  to confirm and the scale is ready for counting.

8-10 Label

Set your own label



Note: The label can save up to 32 characters

1. Keep pressing  until you see the display as shown.

WEIGHT	UNIT WEIGHT	TOTAL COUNT (PCS)
-		

Arrow "▶" pointing at **HI** means that the first 16 characters can be edited.

2. Keep pressing and releasing . The display will show **2, A, b, C** in order. Choose **A** for example,

3. Press  or do nothing for a while to edit the next character. Press  to move leftwards and  to move rightwards.

4. Repeat 2-3 steps to complete the first 16 characters.

5. Press  to complete the next 16 characters. The shown is

Arrow "▶" pointing at **LO** means that the last 16 characters can be edited.



6. Do as steps 2-4

7. Press  to save and return to normal weighing mode.

8-11 Time Setting

1. Press  under normal weighing mode.

WEIGHT	UNIT WEIGHT	TOTAL COUNT (PCS)
200.1	10-23	10:13:16

2. Press  to enter adjusting mode.

3. Press  to move leftwards and  to move rightwards. Use numeric key to input the adjustment.

4. Press  to save and return.

8-12 Error message

E noEE =EEPROM can not be read

E CALF =The calibration range can not be read

PHI =Zero point is too high

PLD =Zero point is too low

E UnSt =Unstable zero point

----- =Overload

OV-15 =The last accumulation is more than the preset accumulation allowed.

8-13 Problem & Solution

Printer can not print out

- Make sure the parameter P-05 is set correctly.
- Make sure the parameter P-06 and P-07 match the printer.
- If EZ-2P or BP-443D is being used, they should have download the printer format before.

HI & LO checking do not work

- Make sure the function is enabled.
- The value of LO is greater than HI.

No sound in HI & LO checking function

Make sure the parameter P-03 is set correctly.

Reset the time every time when the scale is turned on

Connect an optional RTC

How to check whether the printer is compatible to the scale

- Under the parameter P-05, select "normal" printer.
- Check the baud rate (P-06) and the data (P-07) is compatible to printer. If not, please change the setting accordingly.
- Under the normal weighing mode, press  to print. If the printer is able to print, it means that this printer can replace the SH-24 printer.

9. Option

Scale to Printer

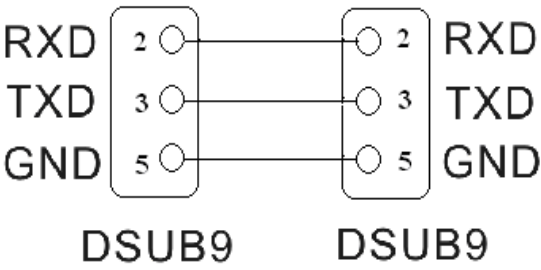
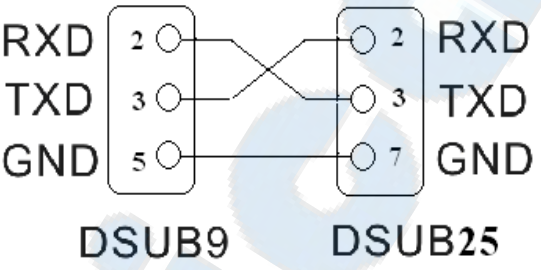
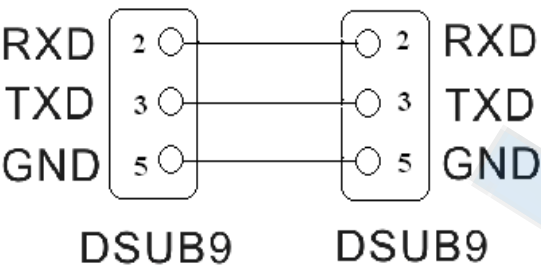
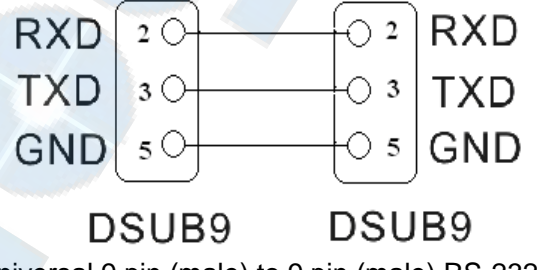
<p style="text-align: center;">Scale to BP545D(TDP) printer</p> <p style="text-align: center;">SCALE BP545D</p>  <p style="text-align: center;">DSUB9 DSUB9</p> <p>Universal 9 pin (male) to 9 pin (male) RS-232 connecting cable.</p>	<p style="text-align: center;">Scale to SH-24 (TP) printer</p> <p style="text-align: center;">SCALE SH-24</p>  <p style="text-align: center;">DSUB9 DSUB25</p> <p>Universal 9 pin (male) to 25 pin (male) RS-232 connecting cable.</p>
<p style="text-align: center;">Scale to ZEBRA printer</p> <p style="text-align: center;">SCALE ZEBRA</p>  <p style="text-align: center;">DSUB9 DSUB9</p> <p>Universal 9 pin (male) to 9 pin (male) RS-232 connecting cable.</p>	<p style="text-align: center;">Scale to EZ printer</p> <p style="text-align: center;">SCALE EZ1100</p>  <p style="text-align: center;">DSUB9 DSUB9</p> <p>Universal 9 pin (male) to 9 pin (male) RS-232 connecting cable.</p>

Scale to PC

1.. Connect the scale and computer by using the RS232 cable as the following picture.

2. Please set the print mode

Manual

Print after ▲▲ appears

Print when quantity is ok(with check function)

Print when weight is ok(with check function)

Print continuously

No action



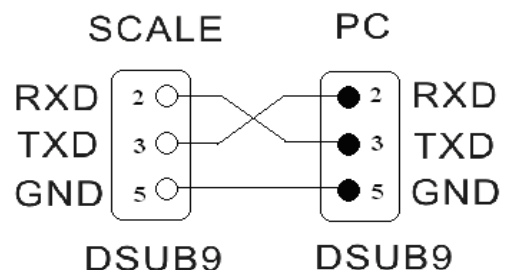





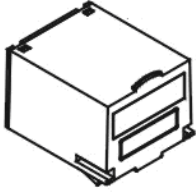

3. Get receiving program ready on your computer.

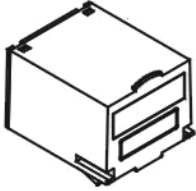

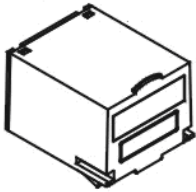
Commonly used 9 female ~9male RS232 connecting cable.

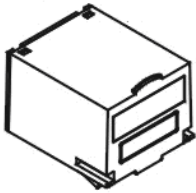
Note: The hollow dots represent male connectors and the black dots represent female connector.

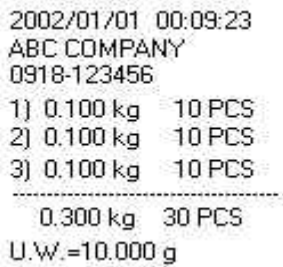
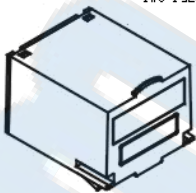
Only one optional device being used

	Option	application	Remark
AP1	<p>Two rs232 port+Relay</p> 	<p>+</p>  <p>BP</p>	<p>Can print out bar code</p> 
AP2	<p>Two rs232 port+Relay</p> 	 <p>Zebra</p>	<p>2009-05-27 14 : 46 : 38 G.W.: 1.000kg U.W.: 0.5g Total : 400PCS</p>
AP3	<p>Two rs232 port+Relay</p> 	 <p>EZ (godex)</p>	
AP4	<p>Two rs232 port+Relay</p> 	<p>+</p>  <p>SH-24</p>	<p>Can print out accumulation data</p> 
AP5	<p>Two rs232 port+Relay</p> 	<p>+</p>  <p>LED Display</p>	<p>→ Only the weighing data can be shown on the LED display</p>

AP6

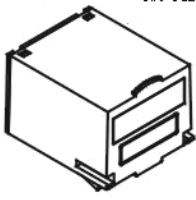

Two rs232 port+Relay

+







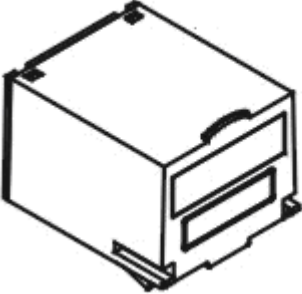

LED Light Tower

Light tower can indicate three different situation
→

Metrologia

Two optional devices being used

	Option	Application
AP1	 <p>Two rs232 port+Relay</p>	 <p>BP/ Or</p>  <p>ZEBRA/ Or</p>  <p>GODEX/ Or</p>  <p>LED Display</p>  <p>LED Light Tower/ Or</p>  <p>PC</p>

AP2

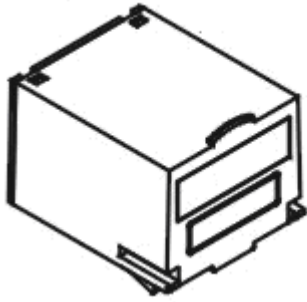

Two rs232 port+Relay



BP/
Or



ZEBRA/
Or



GODEX/
Or









PC

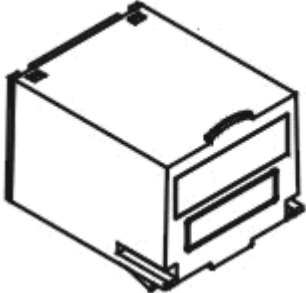

Metrolog

Three optional devices being used

	Option	Application
AP1	<p>Two rs232 port+Relay</p> 	 <p>BP/ Or</p>  <p>ZEBRA/ Or</p>  <p>GODEX/ Or</p>  <p>PC</p>  <p>LED Display And</p>  <p>LED Light Tower</p>

10. Relay Module Diagram

RELAY OUTPUT :

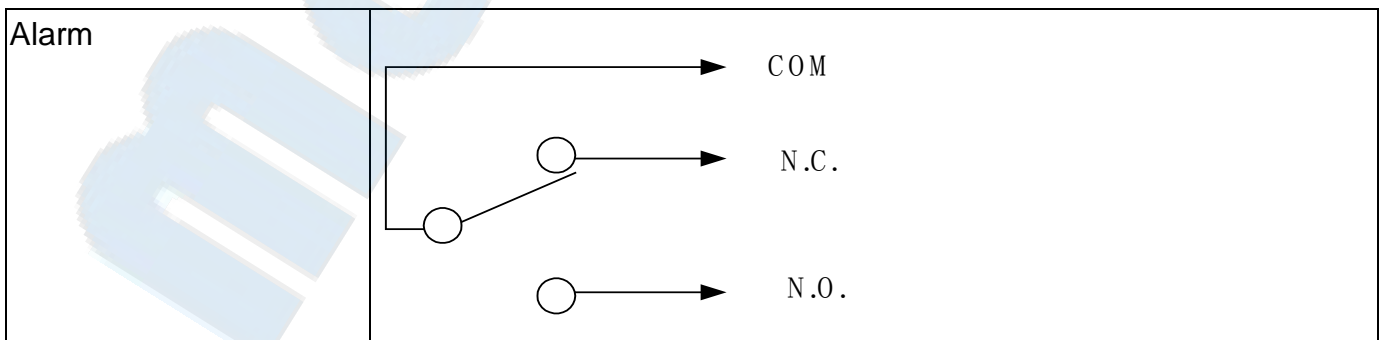

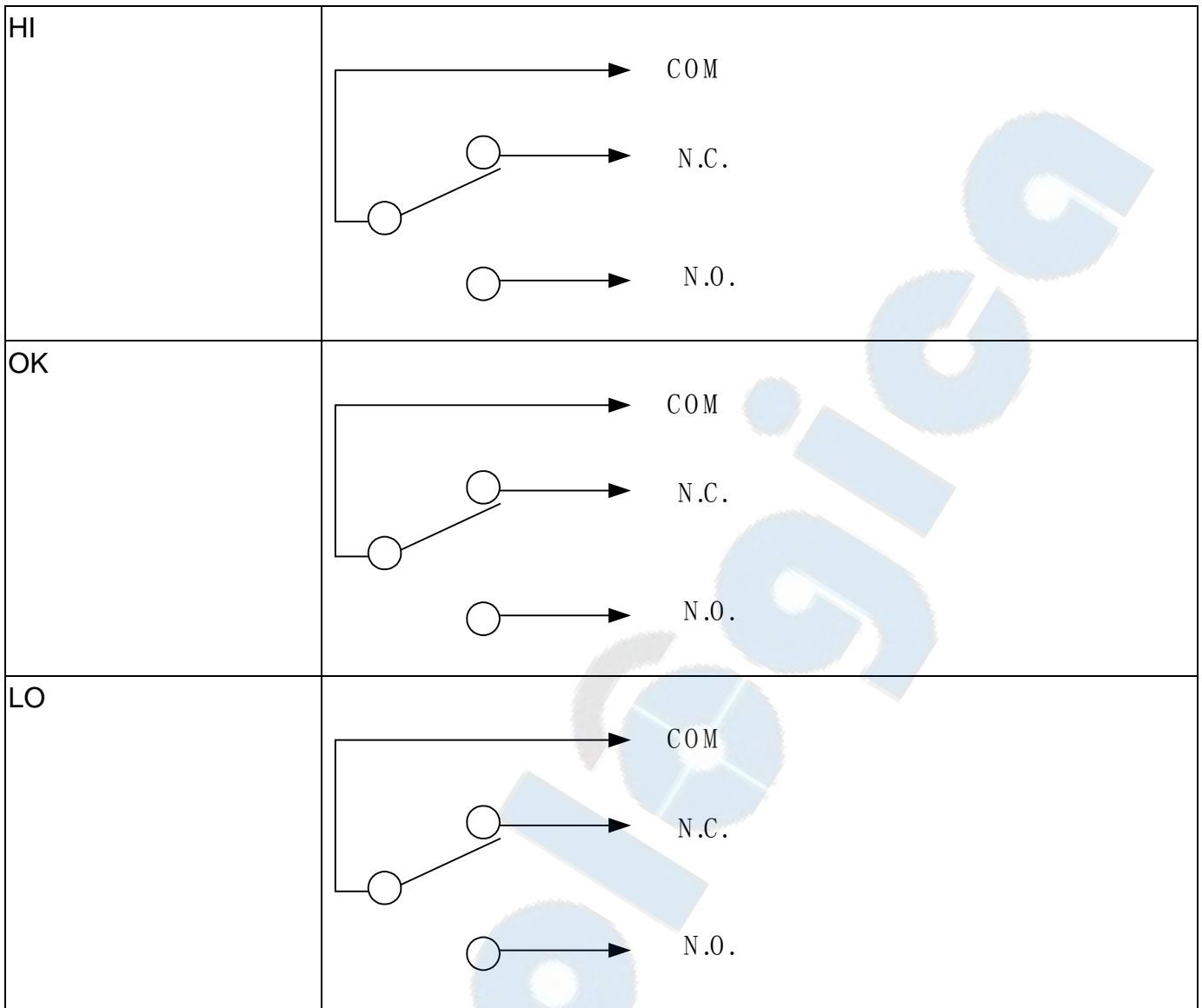

RELAY CONTACT SPEC

1A/24VDC , 0.5A/125VAC , 0.25A/250VDC